

Instructions for use

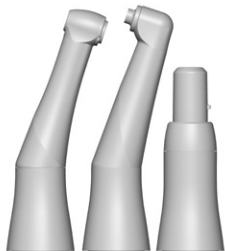

CE
0297



proxeo^{TWIST}

Handpiece head

PL-44

Contra-angle head

PL-66 W, PL-64

Contents

Symbols	4
in the Instructions for use	4
on the medical device / packaging.....	5
1. Introduction	6
2. Safety notes	9
3. Product description	11
4. Operation	12
Assembly/Removal	12
To change the rotary instrument.....	13
Test run	19
5. Hygiene and maintenance	20
General notes	20
Limitations on processing.....	22
Initial treatment at the point of use.....	23

Manual cleaning.....	24
Manual disinfection	25
Automated cleaning and disinfection.....	26
Drying	27
Inspection, Maintenance and Testing.....	28
Packaging	31
Sterilization	32
Storage.....	34
6. Servicing	35
7. W&H Accessories and spare parts	36
8. Technical data.....	37
9. Disposal	39
Explanation of warranty terms.....	40
Authorized W&H service partners	41

Symbols

in the Instructions for use



WARNING!
[risk of injury]



ATTENTION!
[to prevent
damage occurring]



General explanations,
without risk to
persons or objects



Do not dispose
of with domestic waste



Not for re-use

Symbols

on the medical device / packaging



CE marking with identification number of the Notified Body



DataMatrix Code for product information including UDI (Unique Device Identification)



Data structure in accordance with Health Industry Bar Code



Catalogue number



Sterilizable up to the stated temperature



UL Component Recognition Mark indicates compliance with Canadian and U.S. requirements



Serial number



Date of manufacture



Caution! According to Federal law restricts this device to sale by or on the order of a physician, dentist, veterinarian or with the descriptive designation of any other practitioner licensed by the law of the State in which the practitioner practices to use or order the use of the device.



Thermo washer disinfectable

1. Introduction

Customer satisfaction has absolute priority in the W&H quality policy. This medical device has been developed, manufactured and subjected to final inspection according to legal regulations, quality and industry standards.

For your safety and the safety of your patients

Prior to initial use please read the Instructions for use. These explain how to use your medical device and guarantee a smooth and efficient operation.



Observe the safety notes.

Intended use

The Proxeo straight/contra-angle handpiece is intended for cleaning and polishing the tooth surface and fillings.



Misuse may damage the medical device and hence cause risks and hazards for patient, user and third parties.

Qualifications of the user

We have based our development and design of the medical device on the dentists, dental hygienists, dental employees (prophylaxis) and dental assistants target group.

Responsibility of the manufacturer

The manufacturer can only accept responsibility for the safety, reliability and performance of the medical device when it is used in compliance with the following directions:

- > The medical device must be used in accordance with these Instructions for Use.
- > The medical device has no components that can be repaired by the user.
- > Modifications or repairs must only be undertaken by an authorised W&H service partner (see page 41).

Skilled application

The medical device is intended only for skilled application according to the intended use as well as in compliance with the valid health and safety at work regulations, the valid accident prevention regulations and in compliance with these Instructions for Use.



The medical device should be prepared for use and maintained by staff who have been trained in procedures for infection control, personal safety and patient safety.

Improper use, (e.g., through poor hygiene and maintenance), non-compliance with our instructions or the use of accessories and spare parts which are not approved by W&H, invalidates all claims under warranty and any other claims.



Any serious incident that has occurred in relation to the medical device should be reported to the manufacturer and the competent authority!

2. Safety notes

-  > Use only the medical device with the drive handpiece PL-40 HW.
-  > Before using the medical device for the first time, store it at room temperature for 24 hours.
 - > Always ensure the correct operating conditions.
 - > Check the medical device for damage and loose parts each time before using.
 - > Do not operate the medical device if it is damaged.
 - > Perform a test run each time before using.

Hygiene and maintenance prior to initial use



- > The medical device is sealed in PE film and not sterilized when delivered.
- > The PE film and the packaging are non-sterilizable.



- > Clean, disinfect and lubricate the medical device.
- > Sterilize the medical device.

3. Product description

Handpiece-/contra-angle head

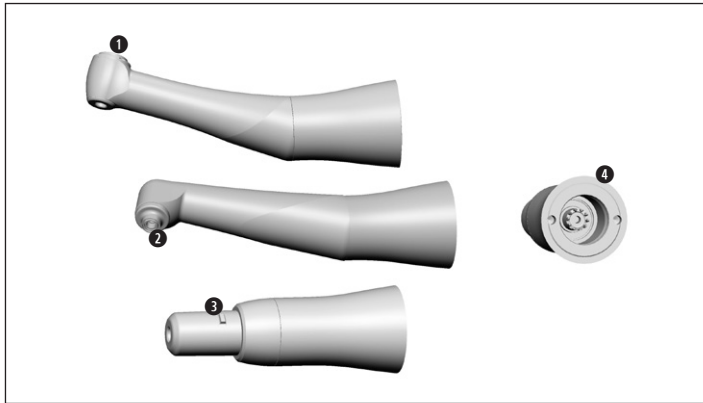

PL-66 W

System LatchShort

❶ Push-button

PL-64

System Screw-in Young

❷ Thread

PL-44

System Doriot

❸ Nose

❹ W&H connection

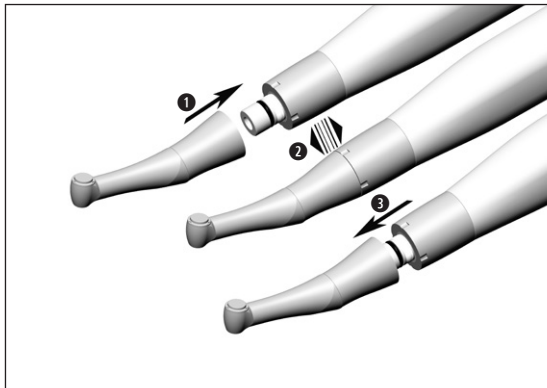

Do not assemble or remove the medical device during operation!

- ① Push the medical device onto the handpiece drive.



- ② Verify full engagement.

or

- ③ Remove the medical device.



Rotary instruments

- > Prophy Cup or Brush System LatchShort
- > Prophy Cup or Brush System Screw-in Young
- > Prophy Angle Cup or Brush System Doriot



- > The rotary instruments are disposable articles and must be discarded after each treatment.



- > Use only rotary instruments which are in perfect condition and approved by W&H (LatchShort). Follow the operating instructions of the manufacturer.
- > Insert the rotary instrument only when the medical device is stationary.
- > Never touch the rotary instrument while it is still rotating.

Contra-angle head PL-66 W (System LatchShort)



- > Use only rotary instruments which have shanks that meet the requirements of the ISO 1797 standard.
- > Do not activate the chucking system of the medical device during operation. This leads to detachment of the rotary instrument, damage to the chucking system and/or heating up of the medical device. Risk of burning!



- > To reach a low working height and ensure tightness, use only W&H Prophy Cups or Brushes for the LatchShort system.

Contra-angle head PL-64 (System Screw-in Young)



- > Only use the straight/contra-angle handpiece in forward operation. The rotary instrument can come loose in reverse operation (risk of injury).



- > The head of the contra-angle head is equipped with a Triple Seal from Young Dental.
- > To ensure tightness and functionality, use only Young Dental Prophy Cups or Brushes for the Screw-in system.

Handpiece head PL-44 (System Doriot)



- > Only use Prophy Angles with plastic shanks for the Doriot system. Prophy Angles with metal shanks damage the clamping chuck system.



- > The handpiece head has an automatic clamping chuck system.

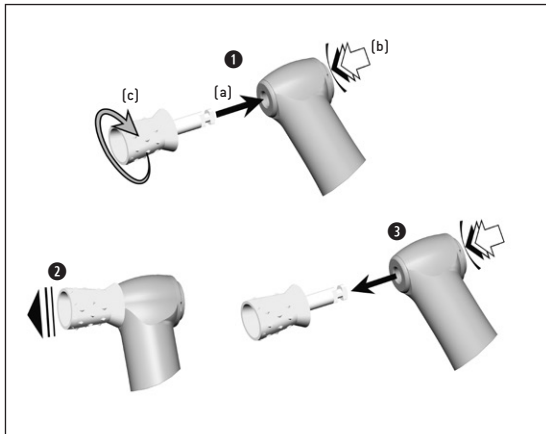

Contra-angle head PL-66 W

- > Prophy Cup or Brush (System LatchShort)
- > Instrument shaft diameter 2.35 mm

❶ Push the Cup or Brush in until the limit stop [a]. Press the push-button [b] and turn the Cup or Brush until it clicks into place [c].



❷ Verify full engagement.

or

❸ Press the push-button and remove the Cup or Brush.



Contra-angle head PL-64

> Prophy Cup or Brush (System Screw-in Young)

❶ Screw the Cup or Brush in until the limit stop.



❷ Verify full engagement.

or

❸ Hold the Cup or Brush firmly.

❹ Keep pressed the ON/OFF button of the handpiece drive.

❺ And press the foot control.

❻ The Cup or Brush is unscrewed.

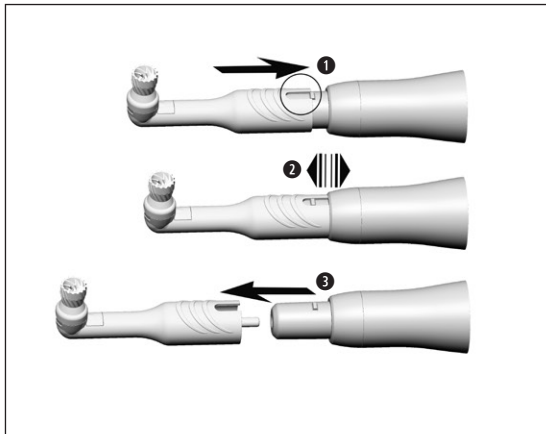

Handpiece head PL-44

> Prophy Angle Cup or Brush (System Doriot)

- 1** Position the groove on the Prophy Angle with the nose of the handpiece head and push it on until the limit stop.



- 2** Verify full engagement.

or

- 3** Remove the Prophy Angle.

Test run



Do not hold the medical device at eye level!

- > Insert the rotary instrument.
- > Operate the medical device.



In the event of operating malfunctions (e.g. vibrations, unusual noises or overheating) **stop the medical device immediately** and contact an authorized W&H service partner.



Follow your local and national laws, directives, standards and guidelines for cleaning, disinfection and sterilization.



> Wear protective clothing, safety glasses, face mask and gloves.



> Use only oil-free, filtered compressed air with a maximum operating pressure of 3 bar for manual drying.

Cleaning agents and disinfectants



- > Read the notes, follow the instructions and heed the warnings provided by the manufacturers of cleaning agents and/or disinfectants.
- > Use only detergents which are intended for cleaning and/or disinfecting medical devices made of metal and plastic.
- > It is imperative to comply with the concentrations and exposure times specified by the manufacturer of the disinfectant.
- > Use disinfectants which have been tested and found effective by the Verbund für Angewandte Hygiene e.V. (VAH = Association for Applied Hygiene), the Österreichischen Gesellschaft für Hygiene, Mikrobiologie und Präventivmedizin (ÖGHMP = Austrian Society for Hygiene, Microbiology and Preventive Medicine), the Food and Drug Administration (FDA) and the U.S. Environmental Protection Agency (EPA).



The user is responsible for validating its process if the specified cleaning agents and disinfectants are not available.



The product lifetime and the medical device's ability to operate correctly are mainly determined by mechanical stress during use and chemical influences due to processing.

- > Send worn or damaged medical devices and/or medical devices with material changes to an authorized W&H service partner.

Processing cycles



- > We recommend a regular service for the W&H medical device after 1,000 processing cycles or one year.



Clean the medical device immediately after every treatment, to flush out liquid (e.g., blood, saliva etc.) and to prevent settling on the internal parts.

- > Operate the medical device for at least 10 seconds at idle speed.
- > Ensure that all coolant outlets are rinsed out.



- > Wipe the entire surface of the medical device with disinfectant.
- > Remove the rotary instrument.
- > Remove the medical device.



Note that the disinfectant used during pre-treatment is only for personal protection and cannot replace the disinfectant step after cleaning.



Do not place the medical device in liquid disinfectant or in an ultrasonic bath.

- > Clean the medical device under running tap water (< 35°C/< 95°F).
- > Rinse and brush off all internal and external surfaces.
- > Move moving parts back and forth several times.
- > Remove liquid residues using compressed air.



> W&H recommends wiping down with disinfectant.



Evidence of the medical device's basic suitability for effective manual disinfection was provided by an independent test laboratory using the disinfectants “mikrozid® AF wipes” (Schülke & Mayr GmbH, Norderstedt) and “CaviWipes™” (Metrex).



W&H recommends automated cleaning and disinfection using a washer-disinfector (WD).

- > Read the notes, follow the instructions and heed the warnings provided by the manufacturers of washer disinfectors, cleaning agents and/or disinfectants.



Evidence of the medical device's basic suitability for effective automated disinfection was provided by an independent test laboratory using the "Miele PG 8582 CD" washer disinfector (Miele & Cie. KG, Gütersloh) and the "Dr. Weigert neodisher® MediClean forte" cleaning agent (Dr. Weigert GmbH & Co. KG, Hamburg) according to ISO 15883.

- > Cleaning at 55°C (131°F) – 5 minutes
- > Disinfection at 93°C (200°F) – 5 minutes



- > Ensure that the medical device is completely dry internally and externally after cleaning and disinfection.
- > Remove liquid residues using compressed air.

Inspection



- > Check the medical device after cleaning and disinfection for damage, visible residual soiling and surface changes.
- > Reprocess any medical devices that are still soiled.
- > Sterilize the medical device following cleaning, disinfection and lubrication.

Lubrication



> Lubricate the dry medical device immediately after cleaning and/or disinfection.

Recommended lubrication cycles

- > Essential after every internal cleaning
 - > Before each sterilization
- or
- > After 30 minutes of use or once a day

With W&H Service Oil F1, MD-400

- > Follow the instructions on the oil spray can and on the packaging.
- or

With W&H Assistina

- > Follow the instructions in the Assistina Instructions for use.

Test after lubrication



- > Direct the medical device downwards.
- > Operate the medical device so that excess oil can escape.
- > Excess oil may result in the medical device overheating.



Pack the medical device and the accessories in sterilization packages that meet the following requirements:

- > The sterilization package must meet the applicable standards in respect of quality and use and must be suitable for the sterilization method.
- > The sterilization package must be large enough for the sterilization goods.
- > The filled sterilization package must not be under tension.



W&H recommends sterilization according to EN 13060, EN 285 or ANSI/AAMI ST55.



- > Read the notes, follow the instructions and heed the warnings provided by the manufacturers of steam sterilizers.
- > The program selected must be suitable for the medical device.

Recommended sterilization procedures

- > “Dynamic-air-removal prevacuum cycle” (type B)
134°C (273°F) for at least 3 minutes, 132°C (270°F) for at least 4 minutes
- > “Gravity-displacement cycle” (type N)
121°C (250°F) for at least 30 minutes
- > Maximum sterilization temperature 135°C (275°F)



Evidence of the medical device's basic suitability for effective sterilization was provided by an independent test laboratory using the LISA 517 B17L* steam sterilizer (W&H Sterilization S.r.l., Brusaporto (BG)) and the CertoClav MultiControl MC2-S09S273** steam sterilizer (CertoClav GmbH, Traun).

“Dynamic-air-removal prevacuum cycle” (type B): 134°C (273°F) – 3 minutes*
132°C (270°F) – 4 minutes*/**
“Gravity-displacement cycle” (type N): 121°C (250°F) – 30 minutes**

Drying times:

“Dynamic-air-removal prevacuum cycle” (type B): 132°C (270°F) – 30 minutes**
“Gravity-displacement cycle” (type N): 121°C (250°F) – 30 minutes**

* EN 13060, EN 285, ISO 17665

** ANSI/AAMI ST55 , ANSI/AAMI ST79



- > Store sterile goods dust-free and dry.
- > The shelf life of the sterile goods depends on the storage conditions and type of packaging.

6. Servicing

Repairs and returns

In the event of operating malfunctions immediately contact an authorized W&H service partner.

Repairs and maintenance work must only be undertaken by an authorized W&H service partner.



- > Ensure that the medical device has been completely processed before returning it.

7. W&H Accessories and spare parts



Use only original W&H accessories and spare parts or accessories approved by W&H!

Suppliers: W&H partners

000301xx	W&H Assistina 301 plus
30310000	W&H Assistina TWIN (MB-302)
05204600	Assistina adaptor for handpiece-/contra-angle head
10940021	W&H Service Oil F1, MD-400 (6 pcs)
02038200	Spray adaptor for straight/contra-angle handpieces
07597900	Prophy Cups, firm / dark green, LatchShort (144 pcs)
08003630	Prophy Cups, soft / apple green, LatchShort (144 pcs)
08003650	Prophy Brushes, cup-shaped, soft / clear, LatchShort (144 pcs)
07979710	Prophy Angle Cup, 105°, firm / dark green (100 pcs)
07994950	Prophy Angle Cup, 105°, soft / apple green (100 pcs)

8. Technical data

Medical device	PL-66 W	PL-64	PL-44
Transmission ratio	4:1		
Maximum drive speed (min ⁻¹)	12,000		
Motor coupling	W&H coupling		
Rotary instruments	System LatchShort Prophy Cups and Brushes	System Screw-in Young Prophy Cups and Brushes	System Doriot Prophy Angle
Maximum speed on the rotating instrument (min ⁻¹)	3.000		
Instrument shaft diameter ISO 1797 (mm)	2.35	–	–

min⁻¹ (revolutions per minute)



Temperature information

Temperature of the medical device on the operator side: maximum 55°C (131°F)

Temperature of the medical device on the patient side: maximum 50°C (122°F)

Temperature of the working part (rotary instrument): maximum 41°C (105.8°F)

Ambient conditions

Temperature during storage and transport:

-40°C to +70°C (-40°F to +158°F)

Humidity during storage and transport:

8% to 80% (relative), non-condensing

Temperature during operation:

+10°C to +35°C (+50°F to +95°F)

Humidity during operation:

15% to 80% (relative), non-condensing

9. Disposal



Ensure that the parts are not contaminated on disposal.



Follow your local and national laws, directives, standards and guidelines for disposal.

- > Medical device
- > Packaging

Explanation of warranty terms

This W&H medical device has been manufactured with great care by highly qualified specialists. A wide variety of tests and controls guarantee faultless operation. Please note that claims under warranty can only be validated when all the directions in the Instructions for use have been followed.

As manufacturer, W&H is liable for material or manufacturing defects within a warranty period of 24 months from the date of purchase. Accessories and consumables are excluded from the warranty.

We accept no responsibility for damage caused by incorrect handling or by repairs carried out by third parties not authorized to do so by W&H!

Claims under warranty accompanied by proof of purchase, must be sent to the vendor or to an authorized W&H service partner. The provision of service under warranty extends neither the warranty period nor any other guarantee period.

24 months warranty

Authorized W&H service partners

Find your nearest authorized W&H service partner at <http://wh.com>
Simply go to the menu option “Service” for full details.

Or simply scan the QR code.



Manufacturer

W&H Dentalwerk Bürmoos GmbH
Ignaz-Glaser-Straße 53, 5111 Bürmoos, Austria

t +43 6274 6236-0, f +43 6274 6236-55
office@wh.com wh.com

Form-Nr. 51036 AEN
Rev. 000 / 01.06.2021
Subject to alterations