

Instructions for use



CE
0297

PEOPLE HAVE PRIORITY



Electric motor
EM-12 L

Supply hose
VE-10

Contents

Symbols	4
1. Introduction	7
2. Safety notes	10
3. Product description	14
4. Operation	16
Screw on the medical device	16
Unscrew the medical device.....	17
Test run	19
5. Hygiene and maintenance	20
General notes	20
Limitations on processing.....	22
Initial treatment at the point of use.....	23
Manual cleaning.....	24
Cleaning of the optic outletn	25

Manual disinfection	26
Drying	27
Inspection, Maintenance and Testing	28
Packaging	29
Sterilization	30
Storage.....	32
6. Maintenance	33
7. Servicing.....	36
8. W&H Accessories and spare parts	38
9. Technical data.....	39
10. Disposal.....	42
Explanation of warranty terms.....	43
Authorized W&H service partners	44



WARNING!
(risk of injury)



ATTENTION!
(to prevent
damage occurring)



General explanations,
without risk to
persons or objects



Do not dispose of
with domestic waste

R_x_{only}

Caution!

According to Federal law, this medical device may only be sold by or on the order of a dentist, physician or any other medical practitioner licensed by the law of the State in which he or she practices and who intends to use or order the use of this medical device

Symbols

on the medical device / packaging



CE marking
with identification number
of the Notified Body



DataMatrix Code
for product information
including UDI (Unique
Device Identification)



Data structure in
accordance with
Health Industry Bar Code



Catalogue number



Sterilizable up to the
stated temperature



Date of manufacture



Serial number



UL Component Recognition Mark
indicates compliance with Canadian and U.S. requirements



Humidity,
Limitation



Permitted
temperature range

Symbols

on the supply hose

REF

Catalogue number

SN

Serial number



Type B applied part
(not suitable for
intracardiac application)

1. Introduction

Customer satisfaction has absolute priority in the W&H quality policy. This medical device has been developed, manufactured and subjected to final inspection according to legal regulations, quality and industry standards.

For your safety and the safety of your patients

Prior to initial use please read the Instructions for use. These explain how to use your medical device and guarantee a smooth and efficient operation.



Observe the safety notes.

Intended use

The electrical drive, EM-12L is indicated for use in the field of preventive dentistry, restorative applications including cavity preparation and endodontic therapy, prosthodontics applications such as crown preparation.



Misuse may damage the medical device and hence cause risks and hazards for patient, user and third parties.

Qualifications of the user

We have based our development and design of the medical device on the dentists, dental hygienists, dental employees (prophylaxis) and dental assistants target group.



0297

Production according to EU Directive

The medical device meets the requirements of Directive 93/42/EEC.

Responsibility of the manufacturer

The manufacturer can only accept responsibility for the safety, reliability and performance of the medical device when it is used in compliance with the following directions:

- > The medical device and the supply hose must be used in accordance with these Instructions for use.
- > The medical device and the supply hose has no components that can be repaired by the user. Assembly, modifications or repairs must only be undertaken by an authorized W&H service partner (see page 44).



HF communication equipment

Do not use any portable and mobile HF communication equipment (e.g. mobile telephones) during operation. These may affect medical electrical equipment.

Skilled application

The medical device is intended only for skilled application according to the intended use as well as in compliance with the valid health and safety at work regulations, the valid accident prevention regulations and in compliance with these Instructions for use.

The medical device should be prepared for use and maintained by staff who have been trained in procedures for infection control, personal safety and patient safety.

Improper use, (e.g., through poor hygiene and maintenance), non-compliance with our instructions or the use of accessories and spare parts which are not approved by W&H, invalidates all claims under warranty and any other claims.

2. Safety notes



- > Before using the medical device for the first time, store it at room temperature for 24 hours.
- > Always ensure the correct operating conditions and cooling function.
- > Always ensure that sufficient and adequate cooling is delivered and ensure adequate suction (except in endodontic applications).
- > In case of coolant supply failure, the medical device must be stopped immediately.
- > Check the medical device for damage and loose parts each time before using.
- > Do not operate the medical device if it is damaged.
- > Use only filtered, oil-free and cooled air supplied by dental compressors to operate the medical device.
- > Perform a test run each time before using.
- > Run the rinse function for the dental unit once per day.
- > Do not look directly into the optic outlet.
- > Never touch the patient and the connection of the supply hose coupling at the same time.



- > The medical device is not approved for operation in potentially explosive atmospheres.
- > The operation of the medical device is permitted only on supply units which correspond to the standards IEC 60601-1 (EN 60601-1) and IEC 60601-1-2 (EN 60601-1-2).



- > Moisture in the medical device may cause a malfunction! (Risk of short circuit)
- > The medical device must not be oiled (pre-oiled for entire service life).
- > Do not twist, kink or squeeze the supply hose (risk of damage)
- > Replace faulty or leaky O-rings immediately
- > The medical device is tailored to the W&H supply hose and the W&H control electronics and must therefore only be used with W&H products. Using other components could lead to deviating parameters or even the destruction of the system.



Risks due to electromagnetic fields

The functionality of implantable systems, such as cardiac pacemakers and implantable cardioverter defibrillators (ICD) can be affected by electric, magnetic and electromagnetic fields.

- > Find out if patient and user have implanted systems before using the medical device and consider the application.
- > Weigh the risks and benefits.
- > Keep the medical device away from implanted systems.
- > Make appropriate emergency provisions and take immediate action on any signs of ill-health.
- > Symptoms such as raised heartbeat, irregular pulse and dizziness can be signs of a problem with a cardiac pacemaker or ICD (implantable cardioverter defibrillator)



Rotational energy

Fast deceleration of the bur can, at times, cause the selected torque to be temporarily exceeded, compared to the value set, as a result of the rotational energy stored in the drive system.



Transmission instruments

- > Follow the directions and safety notes in the Instructions for Use of the dental handpieces.
- > Only use transmission instruments with an ISO 3964 (DIN 13940) compatible coupling system and manufacturer approved transmission instruments.
- > Follow the directions of the manufacturer of dental handpieces with reference to transmission ratio, maximum speed and maximum torque.



Hygiene and maintenance prior to initial use

- > The motor is sealed in PE film and not sterilized when delivered.
- > The PE film and the packaging are non-sterilizable.
- > Clean and disinfect the medical device.
- > Sterilize the motor.

3. Product description

Motor EM-12 L

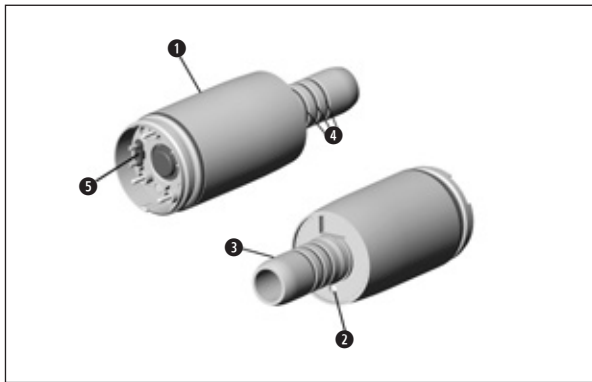

- ① Motor shealt
- ② LED
- ③ Connection for instruments
as per ISO 3964
- ④ O-rings
- ⑤ Seal

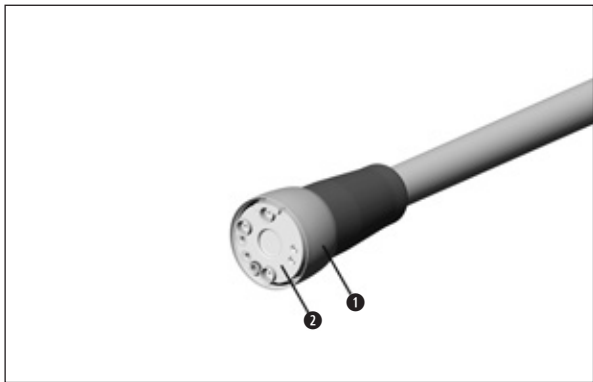

- ① Connection sheat
- ② Connection (quick-release coupling)

4. Operation

Screw on the medical device

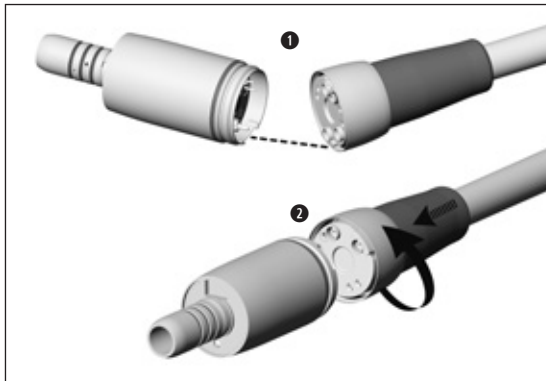

Do not assemble/remove during operation!

- 1 Align the connection tubes of the medical device with the connection openings of the supply hose.
- 2 Screw the medical device and the supply hose together.

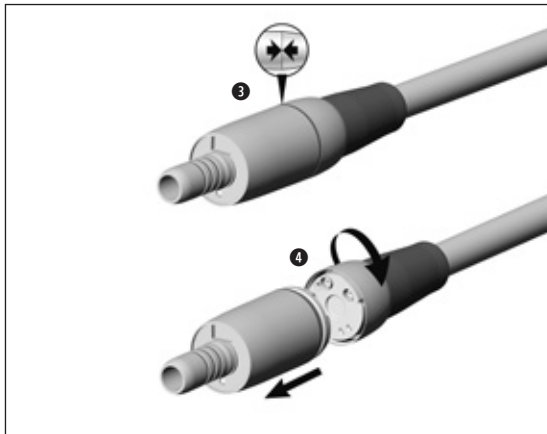

- 3 Carry out a visual inspection. The medical device and supply hose coupling must sit flush to one another.



Verify full engagement.

Unscrew the medical device

- 4 Unscrew the supply hose from the medical device

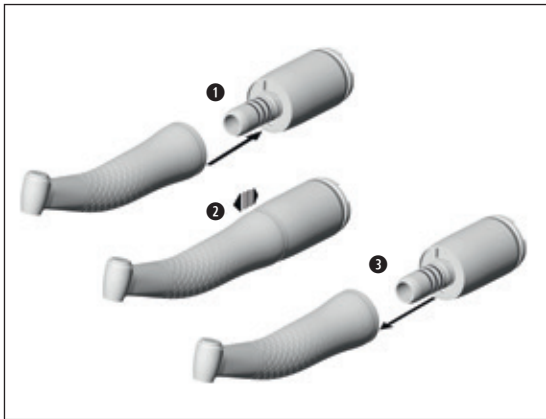

Assembly and removal of transmission instruments



Do not assemble/remove during operation!

- 1 Push the transmission instrument onto the medical device and turn it until it engages audibly.



- 2 Verify full engagement.

- 3 Remove the transmission instrument from the medical device.

Test run



> Do not hold the medical device at eye level.

> Start the medical device using the attached transmission instrument.



In the event of operating malfunctions (e.g., vibrations, unusual noise, overheating, coolant failure or leakage) **stop the medical device immediately** and contact an authorized W&H service partner.



Follow your local and national laws, directives, standards and guidelines for cleaning, disinfection and sterilization.



- > Wear protective clothing, safety glasses, face mask and gloves.
- > Remove the transmission instrument from the medical device.
- > Use only oil-free, filtered compressed air with a maximum operating pressure of 3 bar for manual drying.



- > The motor is not approved for mechanical cleaning (washer disinfectant).
- > Note the dental unit manufacturer's reprocessing instructions for the supply hose.



Cleaning agents and disinfectants

- > Read the notes, follow the instructions and heed the warnings provided by the manufacturers of cleaning agents and/or disinfectants.
- > Use only detergents which are intended for cleaning and/or disinfecting medical devices made of metal and plastic.
- > It is imperative to comply with the concentrations and exposure times specified by the manufacturer of the disinfectant.
- > Use disinfectants which have been tested and found effective by the Verbund für Angewandte Hygiene e.V. (VAH = Association for Applied Hygiene), the Österreichischen Gesellschaft für Hygiene, Mikrobiologie und Präventivmedizin (ÖGHMP = Austrian Society for Hygiene, Microbiology and Preventive Medicine), the Food and Drug Administration (FDA) and the U.S. Environmental Protection Agency (EPA).



The user is responsible for validating its process if the specified cleaning agents and disinfectants are not available.



The product lifetime and the medical device's ability to operate correctly are mainly determined by mechanical stress during use and chemical influences due to processing.

- > Send worn or damaged medical devices and/or medical devices with material changes to an authorized W&H service partner.



Processing cycles

- > We recommend a regular service for the W&H motor after 500 processing cycles or one year.



- > Remove the motor from the supply hose.
- > Clean the medical device immediately after every treatment



Note that the disinfectant used during pre-treatment is only for personal protection and cannot replace the disinfectant step after cleaning..



Do not place the medical device in liquid disinfectant or in an ultrasonic bath.

- > Clean the medical device under running tap water (< 35 °C / < 95 °F).
- > Rinse and brush off all surfaces
- > Remove any liquid residues using compressed air.

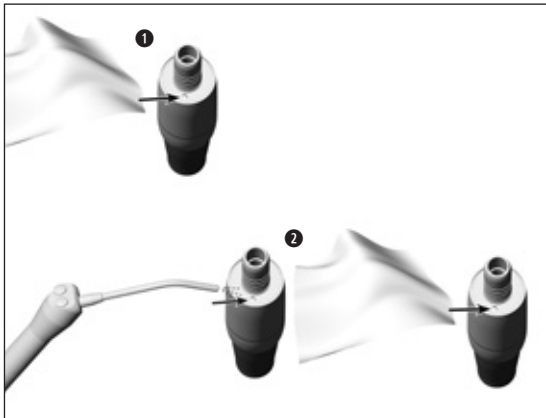

Cleaning of the optic outlet



Avoid scratching of the optic outlet!

- 1 Wash the optic outlet with cleaning fluid and a soft cloth.
- 2 Blow the optic outlet dry with compressed air or dry it carefully with a soft cloth.



Carry out a visual inspection after each cleaning process. Do not use the medical device if the optic outlet is damaged and contact an authorized W&H service partner.



> W&H recommends wiping down with disinfectant.



Evidence of the medical device's basic suitability for effective manual disinfection was provided by an independent test laboratory using the »mikrozid® AF wipes« disinfectant (Schülke & Mayr GmbH, Norderstedt).



- > Ensure that the medical device is completely dry internally and externally after cleaning and disinfection.
- > Remove any liquid residues using compressed air.

Inspection



- > Check the medical device after cleaning and disinfection for damage, visible residual soiling and surface changes.
- > Reprocess any medical devices that are still soiled.
- > Sterilize the motor following cleaning, disinfection and lubrication.



Pack the medical device in sterilization packaging that meet the following requirements:

- > The sterilization package must meet the applicable standards in respect of quality and use and must be suitable for the sterilization method.
- > The sterilization package must be large enough for the sterilization goods.
- > The filled sterilization package must not be under tension.



W&H recommends sterilization according to EN 13060, EN 285 or ANSI/AAMI ST79.



- > Read the notes, follow the instructions and heed the warnings provided by the manufacturers of steam sterilizers.
- > The program selected must be suitable for the motor.

Recommended sterilization procedures

- > Fractionated pre-vacuum process (type B)
- > Gravity displacement process (type N)
- > Sterilization time at least 30 minutes at 121°C (250°F) or at least 3 minutes at 134°C (273°F)
- > Maximum sterilization temperature 135°C (275°F)



Evidence of the medical device's basic suitability for effective sterilization was provided by an independent test laboratory using the LISA 517 B17L steam sterilizer (W&H Sterilization S.r.l., Brusaporto (BG)) and the CertoClav MultiControl MC2-S09S273 gravitation sterilizer (CertoClav GmbH, Traun).

- > Fractionated pre-vacuum process (type B): temperature 134°C (273°F) – 3 minutes*
- > Gravity displacement process (type N): temperature 121°C (250°F) – 30 minutes**

* according to EN 13060, EN 285, ISO 17665 / ** according to ANSI/AAMI ST55 , ANSI/AAMI ST79

- 
- > Store sterile goods dust-free and dry.
 - > The shelf life of the sterile goods depends on the storage conditions and type of packaging.

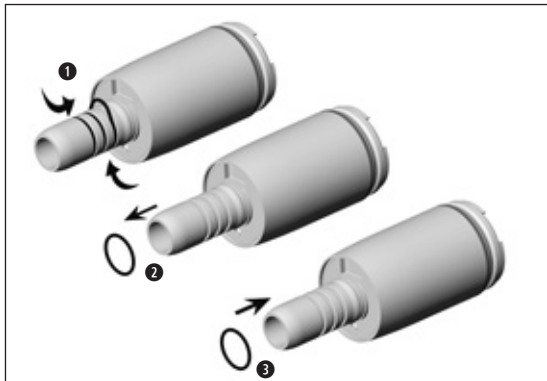

Exchange damaged or leaking O-rings immediately. Do not use sharp instruments!

- 1 Squeeze the O-ring together between thumb and forefinger to form a loop.
- 2 Pull off the O-rings.
- 3 Slide on the new O-rings.



Always change all three O-rings at the same time in order to ensure the tightness of the motor.

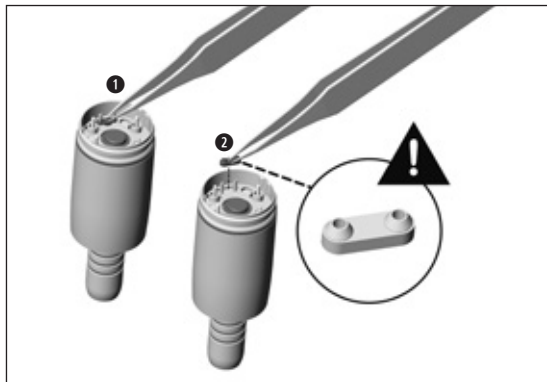

- 1 Lift up the seal with the tip of a pair of tweezers. Remove the seal.
- 2 Carefully insert the new seal.



Pay attention to the positioning of the seal.

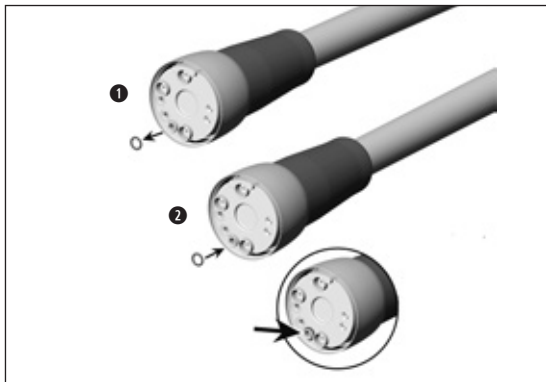

Exchange damaged or leaking O-rings immediately. Do not use sharp instruments!

- 1 Pull off the O-ring.
- 2 Slide on the new O-ring.

7. Servicing



Regular checking

Regular servicing including the accessories is necessary and should be carried out at least once every three years, unless shorter intervals are prescribed by law.

The inspection must be undertaken by a qualified organisation and must include the following procedures:

- > External visual inspection and a check for any changes which could jeopardise safety e. g. mechanical damage of the supply hose.
- > The regular service must only be performed by an authorised W&H service partner.



Repairs and returns

In the event of operating malfunctions immediately contact an authorized W&H service partner.
Repairs and maintenance work must only be undertaken by an authorized W&H service partner.



> Ensure that the medical device has been completely processed before returning it.

8. W&H Accessories and spare parts



Use only original W&H accessories and spare parts or accessories approved by W&H.

Suppliers: W&H service partners

01862300	Motor O-rings (3 pcs)
06893400	Seal (1 pcs)
07072400	Supply hose O-ring (1 pcs)

9. Technical data

Motor	EM-12 L
Coupling hose Transmission instrument according to standard	VE-10 ISO 3964
Direction of rotation	forward/reverse
Speed range	100 – 40,000 rpm
Maximum torque at the motor	3 Ncm
Adjustment cooling air	6 – 8 NI/min
Air coolant pressure* The air coolant pressure has to be higher than the water coolant pressure	0,5 – 3,0 bar
Water coolant volume at (0,5 bar)	> 60 ml/min
Water coolant pressure*	0,5 - 3,0 bar

* Adjust the actual pressure with an attachment in place.

Technical data

Supply hose	VE-10
Approved electric motor	EM-12 L
Drive air respective cooling air at 250 kPa (2,5 bar)	> 8 NI/min
Spray air at 250 kPa (2,5 bar)	> 8 NI/min
Spray water at 200 kPa (2,0 bar)	> 200 ml/min
Maximum pressure	400 kPa (4.0 bar)



Temperature information

Temperature of the medical device on the operator side: maximum 55°C (131°F)

Ambient conditions

Temperature during storage and transport:

-40°C to +70°C (-40°F to +158°F)

Humidity during storage and transport:

8% to 80% (relative), non-condensing

Temperature during operation:

+10°C to +35°C (+50°F to +95°F)

Humidity during operation:

15% to 80% (relative), non-condensing

Altitude:

up to 3,000 m above sea level

10. Disposal



Ensure that the parts are not contaminated on disposal.



Follow your local and national laws, directives, standards and guidelines for disposal.

- > Medical device
- > Waste electrical equipment
- > Packaging

Explanation of warranty terms

This medical device has been manufactured with great care by highly qualified specialists. A wide variety of tests and controls guarantee faultless operation. Please note that claims under warranty can only be validated when all the directions in the Instructions for use have been followed.

As manufacturer, W&H is liable for material or manufacturing defects within a warranty period of 24 months from the date of purchase.

24 months for the motor EM-12 L

12 months for the supply hose VE-10

Accessories and consumables are excluded from the warranty

We accept no responsibility for damage caused by incorrect handling or by repairs carried out by third parties not authorized to do so by W&H!

We accept no responsibility for damage caused by incorrect handling or by repairs carried out by third parties not authorized to do so by W&H!

24/12 months warranty

Authorized W&H service partners

Visit W&H on the Internet at <http://wh.com>

You can find your nearest W&H service partner under “Service” in the menu.

If you do not have Internet access, please contact:

W&H (UK) Limited, Unit 6, Stroud Wood Business Centre, Park Street, St Albans, AL2 2NJ Hertfordshire
t +44 1727 874990, f +44 1727 872254, E-Mail: technical.uk@wh.com

W&H Impex Inc., 6490 Hawthorne Drive, Windsor, Ontario, N8T 1J9, Canada
t +1 519 944 6739, f +1 519 974 6121, E-Mail: service.ca@wh.com

W&H Austria GmbH, Ignaz-Glaser-Straße 53, 5111 Bürmoos, Austria
t +43 6274 6236-239, f +43 6274 6236-890, E-Mail: office.at@wh.com

A-DEC Australia, *Office and showroom*, Unit 8, 5-9 Ricketty Street, 2020 Mascot NSW
t +61 2 8332 4000, f +61 2 8332 4099, E-Mail: a-dec@a-dec.com.au

Manufacturer

W&H Dentalwerk Bürmoos GmbH

Ignaz-Glaser-Straße 53, 5111 Bürmoos, Austria

**t +43 6274 6236-0,
office@wh.com**

**f +43 6274 6236-55
wh.com**

**Form-Nr. 50797 AEN
Rev. 002 / 26.09.2018
Subject to alterations**